

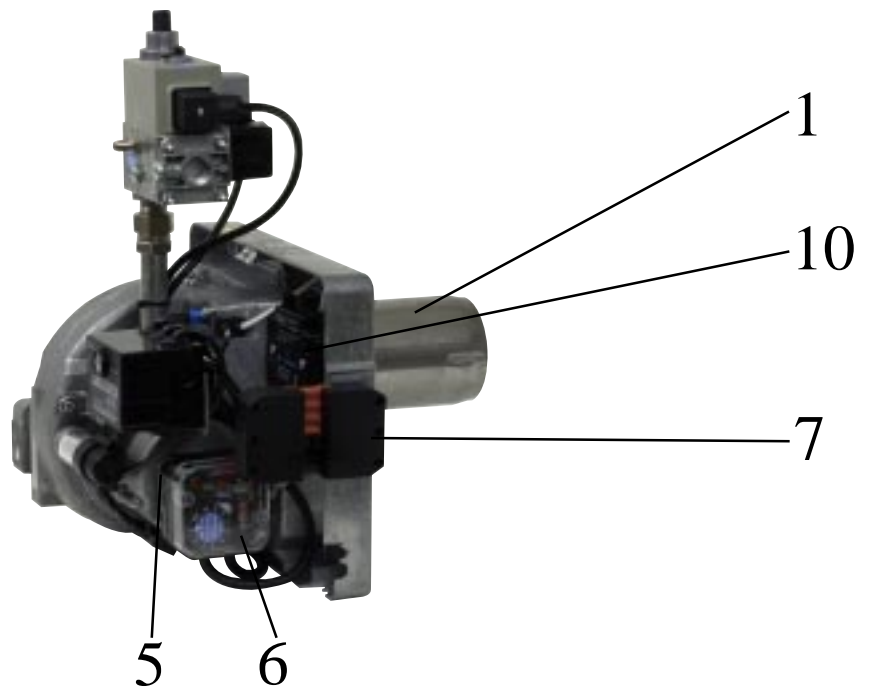

100, 150, 200

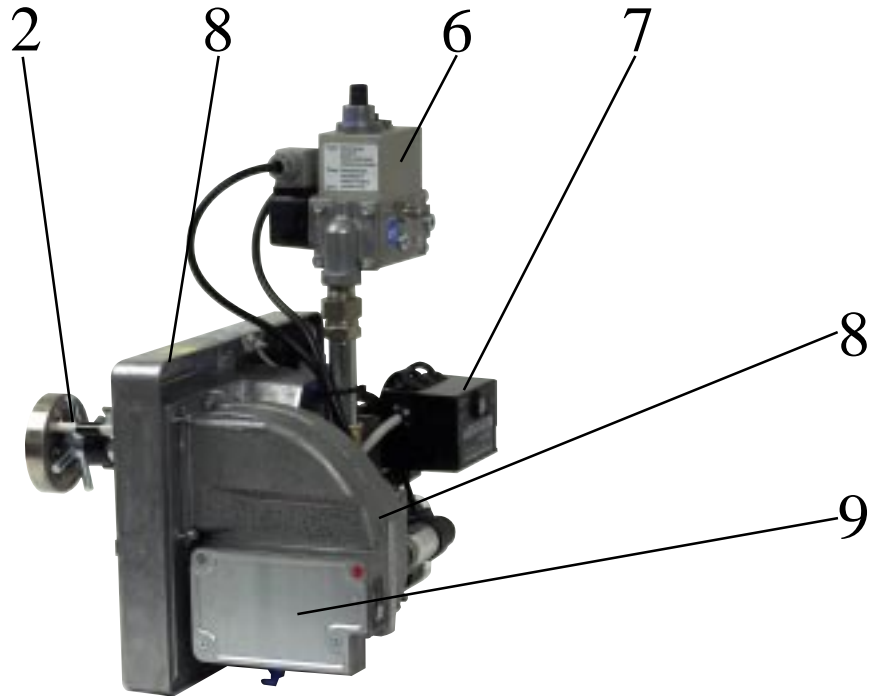

INNEHÅLLSFÖRTECKNING

1. BRÄNNARRÖR	Brännarrör Övrigt
2. INSATS	Insats Bromsskiva Övrigt
3. ANSLUTNINGSFLÄNS	Anslutningsfläns Packning Övrigt
4. KÅPA	Kåpa Fäste Övrigt
5. MOTOR	Motor Fläkthjul Övrigt
6. MULTIBLOCK	Multiblock Vakt Övrigt
7. ELDNINGSAUTOMAT	Eldningsautomat Övrigt
8. FLÄKTHUS	Fläkthus Övrigt
9. LUFTREGLERING	Luftreglering Övrigt
10. TRANSFORMATOR	Transformator Övrigt

TABLE OF CONTENTS

1. BLAST TUBE	Blast tube Other articles
2. INNER ASSEMBLY	Inner assembly Brake plate Other articles
3. FIXING FLANGE	Fixing flange Gasket Other articles
4. COVER	Cover Attachment Other articles
5. MOTOR	Motor Fan wheel Other articles
6. MULTI-BLOC	Multi-Bloc Pressure switch Other articles
7. GAS BURNER CONTROL	Gas burner control Other articles
8. FAN HOUSING	Fan housing Other articles
9. AIR REGULATION	Air regulation Other articles
10. TRANSFORMER	Transformer Other articles

INHALTSVERZEICHNIS

1. BRENNERROHR	Brennerrohr Sonstiges
2. DÜSENSTOCK	Düsenstock Stauscheibe Sonstiges
3. BEFESTIGUNGS - FLANSCH	Befestigungsflansch Dichtung Sonstiges
4. ABDECKHAUBE	Abdeckhaube Befestigung Sonstiges
5. MOTOR	Motor Gebläserad Sonstiges
6. MULTI-BLOC	Multi-Bloc Druckregler Sonstiges
7. GASFEURUNGS- AUTOMAT	Gasfeuerungsautomat Sonstiges
8. BRENNERGEHÄUSE	Brennergehäuse Sonstiges
9. LUFTREGELUNG	Luftregelung Sonstiges
10. TRANSFORMATOR	Transformator Sonstiges

TABLE DES MATIERES

1. TUBE DIFFUSEUR	Tube diffuseur D'autres articles
2. LIGNE PORTE- GICLEUR	Ligne porte-gicleur Disque accroche-flamme D'autres articles
3. BRIDE DE FIXATION	Bride de fixation Joint D'autres articles
4. CAPOT	Capot Fixation D'autres articles
5. MOTEUR	Moteur Rotor D'autres articles
6. MULTI BLOC	Multi Bloc Pressostat gaz D'autres articles
7. COFFRET DE SECURITE	Coffret de sécurité D'autres articles
8. CARTER DU ROTOR	Carter du rotor D'autres articles
9. REGLAGE D'AIR	Réglage d'air D'autres articles
10. TRANSFORMATEUR	Transformateur D'autres articles

100, 150, 200

BRÄNNARRÖR BRENNERROHR

BURNER TUBE TUBE DIFFUSEUR

1



Brännarrör
147 mm
94 mm
224 mm
100, 150

Burner tube
147 mm
94 mm
224 mm
100, 150

Brennerrohr
147 mm
94 mm
224 mm
100, 150

Tube diffuseur
147 mm
94 mm
224 mm
100, 150

117 385 02**117 385 04****117 385 06**

Brännarrör
145 mm
245 mm
Stadsgas
125 mm
200

Burner tube
145 mm
245 mm
Town gas
125 mm
200

Brennerrohr
145 mm
245 mm
Stadtgas
125 mm
200

Tube diffuseur
145 mm
245 mm
Gaz de ville
125 mm
200

117 517 01**117 517 03****117 517 02**

Fästring
200

Fixing ring
200

Befestigungsring
200

Bague de fixation
200

117 267 01

	Insats	Inner assembly	Gasdüsenstock	Ligne porte-gicleur	
	Standard Propan/naturgas	Standard design LPG/Natural gas	Standard Flüssiggas/Erdgas	Modèle standard Gaz propane/gaz naturel	118 248 01
	Stadsgas förlängt utf. Propan/naturgas	Town gas lengthened design LPG/Natural gas	Stadtgas verlängerte ausf. Flüssiggas/Erdgas	Gaz de ville Modèle allongée Gaz propane/gaz naturel	118 248 02
	Stadsgas 100	Town gas 100	Stadtgas 100	Gaz de ville 100	118 248 03
	Insats	Inner assembly	Gasdüsenstock	Ligne porte-gicleur	
	Propan/naturgas	LPG/Natural gas	Flüssiggas/Erdgas	Gaz propane/gaz naturel	118 667 01
	Förlängt utf. 150	lengthened design 150	verlängerte ausf. 150	Modèle allongée 150	118 667 03
	Insats	Inner assembly	Gasdüsenstock	Ligne porte-gicleur	
	Standard Propan/naturgas	Standard design LPG/Natural gas	Standard Flüssiggas/Erdgas	Modèle standard Gaz propane/gaz naturel	117 545 02
	Stadsgas förlängt utf. Propan/naturgas 200	Town gas lengthened design LPG/Natural gas 200	Stadtgas verlängerte ausf. Flüssiggas/Erdgas 200	Gaz de ville Modèle allongée Gaz naturel/gaz propane 200	117 545 03
					117 545 05
	Bromsskiva 100, 150	Brake plate 100, 150	Stauscheibe 100, 150	Disque accroche-flamme 100, 150	117 909 01
	Munstycke Propan/naturgas	Nozzle LPG/Natural gas	Düse Flüssiggas/Erdgas	Gicleur Gaz propane/gaz naturel	
	130 mm 100, 150	130 mm 100, 150	130 mm 100, 150	130 mm 100, 150	117 868 01
	100 mm 150	100 mm 150	100 mm 150	100 mm 150	117 868 02
	Propan/naturgas 200	LPG/Natural gas 200	Flüssiggas/Erdgas 200	Gaz propane/gaz naturel 200	117 968 03
	Stadsgas 100, 150	Town gas 100, 150	Stadtgas 100, 150	Gaz de ville 100, 150	117 968 02
	Luffördelare före 9717	Air distributor before 9717	Luftverteiler vor 9717	Distributeur d'air avant 9717	114 855 01
	efter 9717	after 9717	nach 9717	après 9717	114 855 02
	100, 150	100, 150	100, 150	100, 150	
	Distanshylsa 100, 150	Spacing sleeve 100, 150	Abstandshülse 100, 150	Douille d'écartement 100, 150	114 937 01

	O-ring, insatsrör 17.0 x 1,6 100, 150 O-ring, insatsrör 23,52x1,78 200	O-ring, tube 17,0 x 1,6 100, 150 O-ring, tube 23,52x1,78 200	O-ring, Rohr 17.0 x 1,6 100, 150 O-ring, Rohr 23,52x1,78 200	Rondelle, tube 17.0x1,6 100, 150 Rondelle, tube 23,52x1,78 200	113 168 21 113 168 01
	Förlängning 100	Extension piece 100	Verlängerung 100	Pièce d'allongement 100	117 875 01
	Klammer 100, 150	Bracket 100, 150	Klammer 100, 150	Crampon 100, 150	114 909 03
	Klammer 100, 150	Bracket 100, 150	Klammer 100, 150	Crampon 100, 150	114 909 02
	Elektrodhållare 200	Electrode holder 200	Elektrodenhalter 200	Support d'électrode 200	117 196 01
	Fästskruv 100, 150	Spacing screw 100, 150	Befestigungs- schraube 100, 150	Vis de fixation 100, 150	117 865 01
	Dragstång 220 mm 297 mm 167 mm 100	Pull rod 220 mm 297 mm 167 mm 100	Zugstange 220 mm 297 mm 167 mm 100	Tirant 220 mm 297 mm 167 mm 100	117 864 01 117 864 02 117 864 03
	Dragstång 200 mm 147 mm 277 mm 150	Pull rod 200 mm 147 mm 277 mm 150	Zugstange 200 mm 147 mm 277 mm 150	Tirant 200 mm 147 mm 277 mm 150	117 864 04 117 864 05 117 864 06
	Joniserings- elektrod 100, 150, 200	Ionisation electrode 100, 150, 200	Ionisations- elektrode 100, 150, 200	Electrode d'ionisation 100, 150, 200	115 347 03
	Tändelektrod 100. 150, 200	Ignition electrode 100, 150, 200	Zündelektrode 100. 150, 200	Electrode d'allumage 100. 150, 200	115 347 04





	Insatsrör	Tube	Rohr	Tube	
	118 mm	118 mm	118 mm	118 mm	118 585 01
	95 mm	95 mm	95 mm	95 mm	118 585 02
	195 mm	195 mm	195 mm	195 mm	118 585 03
	150	150	150	150	
	Munstycke kpl.	Nozzle compl.	Düse kompl.	Gicleur compl.	
	Naturgas	Natural gas	Erdgas	Gaz naturel	117 970 06
	Propangas	LPG	Flüssiggas	Gaz propane	117 970 07
	Stadsgas	Town gas	Stadtgas	Gaz de ville	117 970 08
	200	200	200	200	
	Bromsskiva	Brake plate	Stauscheibe	Disque accroche-flamme	
	Propan/naturgas	LPG/Natural gas	Flüssiggas/ Erdgas	Gaz propane/ gaz naturel	117 544 01
	Stadsgas	Towngas	Stadtgas	Gaz de ville	117 544 03
	2020	2020	2020	2020	117 544 07
	2030	2030	2030	2030	117 544 08
	200	200	200	200	
	Bromsskiva med nit	Brake plate with rivet	Stauscheibe mit Niet	Disque accroche-flamme avec rivet	919 418 01
	200	200	200	200	
	Insatsrör	Tube	Rohr	Tube	
	Standard	Standard design	Standard	Modèle standard	117 543 01
	Förlängt utf.	Lengthened design	Verlängte Ausf.	Modèle allongée	117 543 02
	200	200	200	200	
	Dragstång	Pull rod	Zugstange	Tirant	
	Standard	Standard design	Standard	Modèle standard	117 550 01
	Förlängt utf.	Lengthened design	Verlängte Ausf.	Modèle allongée	117 550 02
	200	200	200	200	

100, 150, 200

ANSLUTNINGSLÄNS ANSCHLUSSFLANSCH

FIXING FLANGE BRIDE DE FIXATION

3

	Anslutningsfläns 100, 150	Fixing flange 100, 150	Anschlussflansch 100, 150	Bride de fixation 100, 150	118 246 01
	Anslutningsfläns 200	Fixing flange 200	Anschlussflansch 200	Bride de fixation 200	117 389 02
	Packning 100, 150 200	Gasket 100, 150 200	Dichtung 100, 150 200	Joint 100, 150 200	118 191 01 117 398 01
	Skriv 100	Screw 100	Schraube 100	Vis 100	114 121 62
	Axel 150, 200	Axle 150, 200	Achse 150, 200	Arbre 150, 200	117 352 03

	Kåpa röd svart grå 100 serie2	Cover red black grey 100 series 2	Abdeckhaube rot schwarz grau 100 Serie2	Capôt rouge noir gris 100 série 2	117 883 09 117 883 10 117 883 13
	Kåpa röd grå svart 150, 200 serie 2	Cover red grey black 150, 200 series 2	Abdeckhaube rot grau schwarz 150, 200 Serie 2	Capôt rouge gris noir 150, 200 série 2	117 883 14 117 883 15 117 883 16
	Fäste 100 serie 2 150, 200 serie 2	Bracket 100 series 2 150, 200 series 2	Halter 100 Serie 2 150, 200 Serie2	Support 100 série 2 150, 200 série 2	117 897 01 117 897 02
	Styrskiva 100 serie 1	Guide plate 100 series 1	Befestigungs- platte 100 Serie 1	Plaque de fixation 100 série 1	117 070 01
	Fäste 100 serie 1	Bracket 100 series 1	Halter 100 Serie 1	Support 100 série 1	117 068 01
	Täckbricka 100 serie 2, 150 200 serie 2	Cover plate 100 series 2, 150 200 series 2	Abdeckplatte 100 Serie 2, 150 200 Serie 2	Plaque de recouvrement 100 série 2, 150 200 série 2	117 892 01
	Täckbricka 100 serie 2, 150 200 serie 2	Cover plate 100 series 2, 150 200 series 2	Abdeckplatte 100 Serie 2, 150 200 Serie 2	Plaque de recouvrement 100 série 2, 150 200 série 2	117 892 02
	Skruv 100 serie 2, 150 200 serie 2	Screw 100 series 2, 150 200 series 2	Schraube 100 Serie 2, 150 200 Serie 2	Vis 100 série 2, 150 200 série 2	117 900 01
	Återställnings- knapp 200 serie 1	Reset button 200 series 1	Entstörtaste 200 Serie 1	Bouton de réarmement 200 série 1	115 877 01

	Motor 90W AEG 100, 150, 200	Motor 90W AEG 100, 150, 200	Motor 90W AEG 100, 150, 200	Moteur 90W AEG 100, 150, 200	915 931 01
	Motor 125W Simel AEG 200-2	Motor 125W Simel AEG 200-2	Motor 125W Simel AEG 200-2	Moteur 125W Simel AEG 200-2	917 757 01 919 319 01
	Fläkt hjul 100 150, 200	Fan wheel 100 150, 200	Gebläserad 100 150, 200	Rotor 100 150, 200	115 927 01 117 276 01
	Kondensator AEG 100, 150, 200	Capacitor AEG 100, 150, 200	Kondensator AEG 100, 150, 200	Condensateur AEG 100, 150, 200	115 965 01
	Kabel 100, 150, 200	Cable 100, 150, 200	Kabel 100, 150, 200	Câble 100, 150, 200	117 034 01
	Kondensator med hylsa 200-2	Capacitor with sleeve 200-2	Kondensator mit Hülse 200-2	Condensateur avec douille 200-2	917 751 02

	Multiblock MBDLE 403B01S50 Filter Spole MB224397 100, 150, 200	MultiBloc MBDLE 403B01S50 Filter Coil MB224397 100, 150, 200	MultiBloc MBDLE 403B01S50 Filter Spule MB224397 100, 150, 200	MultiBloc MBDLE 403B01S50 Filtre Bobine MB224397 100, 150, 200	115 632 07 119 163 01 115 688 01
	Multiblock MBDLE 407B01S50 Filter Spole MB224398 100, 150, 200	MultiBloc MBDLE 407B01S50 Filter Coil MB224398 100, 150, 200	MultiBloc MBDLE 407B01S50 Filter Spule MB224398 100, 150, 200	MultiBloc MBDLE 407B01S50 Filtre Bobine MB224398 100, 150, 200	115 670 91 119 164 01 115 688 02
	Multiblock MBDLE 405B01S50 Filter Spole MB224398 200	MultiBloc MBDLE 405B01S50 Filter Coil MB224398 200	MultiBloc MBDLE 405B01S50 Filter Spule MB224398 200	MultiBloc MBDLE 405B01S50 Filtre Bobine MB224398 200	115 670 95 119 164 01 115 688 02
	Multiblock MBZRDLE 407B01S50 Filter 200	MultiBloc MBZRDLE 407B01S50 Filter 200	MultiBloc MBZRDLE 407B01S50 Filter 200	MultiBloc MBZRDLE 407B01S50 Filtre 200	115 671 91 119 164 01
	Tryckvakt LGW 10A2 1- 10mbar 100, 150, 200 GW 50A-5 200	Pressure switch LGW 10A2 1- 10mbar 100, 150, 200 GW 50A-5 200	Druckwächter LGW 10A2 1- 10mbar 100, 150, 200 GW 50A-5 200	Pressostat LGW 10A2 1- 10mbar 100, 150, 200 GW 50A-5 200	115 319 06 115 319 26
	Fläns MB 405/407 R 1/2" R 3/4" 100, 150, 200	Flange MB 405/407 R 1/2" R 3/4" 100, 150, 200	Flansch MB405/407 R 1/2" R 3/4" 100, 150, 200	Bride MB 405/407 R 1/2" R 3/4" 100, 150, 200	115 667 02 115 667 03
	Fläns R 1/2" 100, 150, 200	Flange R 1/2" 100, 150, 200	Flansch R 1/2" 100, 150, 200	Bride R 1/2" 100, 150, 200	115 641 13
	Fläns, vinkel R 1/2" 100, 150, 200	Flange, angle R 1/2" 100, 150, 200	Flansch, Winkel R1/2" 100, 150, 200	Bride, angle R 1/2" 100, 150, 200	115 641 04
	Kulventil 1/2" 1" 100, 150, 200	Ball valve 1/2" 1" 100, 150, 200	Kugelhahn 1/2" 1" 100, 150, 200	Vanne d'arrêt 1/2" 1" 100, 150, 200	113 961 01 113 961 02

	Nippel 1/2" 100, 150, 200 Nippel 3/4"-1" 200	Nipple 1/2" 100, 150, 200 Nipple 3/4"-1" 200	Nippel 1/2" 100, 150, 200 Nippel 3/4"-1" 200	Raccord 1/2" 100, 150, 200 Raccord 3/4"-1" 200	114 637 01 114 637 05
	Fästplatta, tryckvakt 100, 150, 200	Fixing plate, pressure switch 100, 150, 200	Befestigungs- platte, Druckwächter 100, 150, 200	Plaque de fixation, pressostat 100, 150, 200	115 652 01
	Tätthetskontroll VPS504S02 150, 200	Valve, leak tester VPS504S02 150, 200	Dichtkontrolle VPS504S02 150, 200	Controle d'étanchéité VPS504S02 150, 200	118 617 01
	Fläns, vinkel Stadsgas 200	Flange, angle Town gas 200	Flanch, Winkel Stadtgas 200	Bride, angle Gaz de ville 200	119 068 08
	Mät nipple 1/8"	Test nipple 1/8"	Messnippel 1/8"	Raccord de mesure 1/8"	115 427 01
	Ersättning för VDK	Replacement for VDK	Ersatz für VDK	Remplacement de VDK	115 618 02

100, 150, 200

ELDNINGSAUTOMAT GASFEURUNGSAUTOMAT

GAS BURNER CONTROL COFFRET DE SECURITE 7

	Ersättning för LFI 100, 200	Replacement for LFI 100, 200	Ersatz für LFI 100, 200	Remplacement de LFI 100, 200	119 919 01
	Reläsocket LFI kpl. 100, 200	Relay base LFI compl. 100, 200	Unterteil LFI kompl. 100, 200	Socle LFI compl. 100, 200	113 479 00
	Reläbox LMG21 Styckförpackning	Control box LMG21 Single-piece package	Steuergerät LMG21 Stückverpackung	Boîte de contrôle LMG21 Emballage par pièces	919 293 01
	Industriförpackning 100, 150, 200	Industrial package 100, 150, 200	Industrie verpackung 100, 150, 200	Emballage industriel 100, 150, 200	119 293 01
	Adapter KF8853-K	Adapter KF8853-K	Adapter KF8853-K	Adapteur KF8853-K	119 317 01
	Reläsocket LGB, LMG 100, 150, 200	Relay base LGB, LMG 100, 150, 200	Unterteil LGB, LMG 100, 150, 200	Socle LGB, LMG 100, 150, 200	915 596 00
	Reläbox TFI	Control box TFI	Steuergerät TFI	Boîte de contrôle TFI	118 443 01
	MMI 810M.35 100, 150	MMI 810M.35 100, 150	Mmi 810M.35 100, 150	MMI 810M.35 100, 150	118 444 03
	MMI 810M.43 200	MMI 810M43 200	MMI 810M.43 200	MMI 810M.43 200	118 444 02
	Reläsocket TFI 100, 150	Relay base TFI 100, 150	Unterteil TFI 100, 150	Socle TFI 100, 150	90 390 109 01
	MMI 100, 150, 200	MMI 100, 150, 200	MMI 100, 150, 200	MMI 100, 150, 200	918 448 01
	Kontakt don 7-pol handel 100, 150, 200	Plug-in contact 7-pole male 100, 150, 200	Steckerteil 7-polig 100, 150, 200	Prise, mâle, 7 plots 100, 150, 200	115 585 00
	Kontakt don 7-pol hondel 100 serie 2 150, 200 serie 2	Plug-in contact 7-pole female 100 series 2 150, 200 series 2	Buchsenteil 7-polig 100 Serie 2 150, 200 serie 2	Prise, femelle, 7 plots 100 série 2 150, 200 série 2	115 586 04

	Kontakt 7-pol honel 100 serie 1 200 serie 1	Plug-in contact 7-pole female 100 series 1 200 series 1	Buchsenteil 7-polig 100 Serie 1 200 Serie 1	Prise, femelle, 7 plots 100 série 1 200 série 1	118 101 01
	Kontakt 7-pol honel 100 serie 1	Plug-in contact 7-pole female 100 series 1	Buchsenteil 7-polig 100 Serie 1	Prise, femelle, 7 plots 100 série 1	115 586 05
	Kontakt 4-pol hane 200-2	Plug-in contact 4-pole male 200-2	Steckerteil 4-polig 200-2	Prise, mâle, 4 plots 200-2	119 197 01
	Kontakt 4-pol hona 200-2	Plug-in contact 4-pole female 200-2	Buchsenteil 4-polig 200-2	Prise, femelle, 4 plots 200-2	119 198 01
	Kåpa 200-2	Cover 200-2	Abdeckhaube 200-2	Capôt 200-2	110 472 01
	Panel 150, 200	Cover 150, 200	Deckel 150, 200	Panneau 150, 200	117 322 01
	Panel 200-2	Cover 200-2	Deckel 200-2	Support 200-2	117 539 02
	Strömbrytare 0-1 200-2	Switch 0-1 200-2	Schalter 0-1 200-2	Interrupteur 0-1 200-2	117 212 01
	Strömbrytare 1-11 200-2	Switch 1-11 200-2	Schalter 1-11 200-2	Interrupteur 1-11 200-2	117 212 02
	Indikeringslampa grön 200-2	Indicating lamp green 200-2	Anzeigelampe grün 200-2	Lampe témoin vert 200-2	117 211 03

100, 150, 200

ELDNINGSAUTOMAT GASFEURUNGSAUTOMAT

GAS BURNER CONTROL COFFRET DE SECURITE 7



Timräknare
200

Time meter
200

Betriebs-
stundenzähler
200

Compteur horaire
200

117 678 01



UV-cell
QRA2 kpl.
150

UV cell
QRA2 compl.
150

UV-Zelle
QRA2 kompl.
150

Cellule UV
QRA2 compl.
150

914 634 01

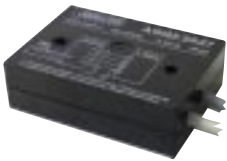





Förstärkare
AGQ2.A27
LMG/UV
150

Amplifier
AGQ2.A27
LMG/UV
150

Verstärker
AGQ2.A27
LMG/UV
150

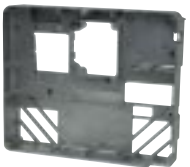
Amplificateur
AGQ2.A27
LMG/UV
150

118 983 02

	Fläkthus 100 serie 2	Fan housing 100 series 2	Brennergehäuse 100 Serie 2	Carter du rotor 100 série 2	119 336 02
	Fläkthushalva vänster höger 150, 200	Fan housing half left right 150, 200	Brennergehäuse linke Hälfte rechte Hälfte 150, 200	Carter du rotor moitié gauche moitié droite 150, 200	117 091 02 117 092 01
	Ram 100 serie 2	Frame 100 series 2	Rahmen 100 Serie 2	Cadre 100 série 2	117 866 01
	Ram 150, 200-1 serie2	Frame 150, 200-1 series 2	Rahmen 150, 200-1 Serie2	Cadre 150, 200-1 série2	118 475 02
	Ram 200-2 serie 2	Frame 200-2 series 2	Rahmen 200-2 Serie 2	Cadre 200-2 série 2	118 475 03
	Lock 100 serie 2	Cover 100 series 2	Deckel 100 Serie 2	Couvercle 100 série 2	117 867 01
	Lock 150, 200 serie 2	Cover 150, 200 series 2	Deckel 150, 200 Serie 2	Couvercle 150, 200 série 2	118 323 01
	Låsstycke 150, 200	Locking piece 150, 200	Verriegelungs- stück 150, 200	Pièce de blocage 150, 200	117 353 01
	Täckplåt 200 serie 1 200-2 serie 2	Covering plate 200 series 1 200-2 series 2	Deckplatte 200 Serie1 200-2 Serie 2	Plaque de recouvrement 200 série 1 200-2 série2	117 349 01

	Luftintag 100 serie 2	Air intake 100 series 2	Luftansaug- gehäuse 100 Serie 2	Caisson d'admission d'air 100 série 2	117 941 01
	Luftintag 200 serie 1 200-2 serie 2	Air intake 200 series 1 200-2 series 2	Luftansaug- gehäuse 200 Serie 1 200-2 Serie 2	Caisson d'admission d'air 200 série 1 200-2 série 2	117 660 02
	Ställklack 100 serie 1	Locating block 100 series 1	Regulierstück 100 Serie 1	Dispositif de réglage de l'air 100 série 1	117 280 01
	Ställklack 200 serie 1	Locating block 200 series 1	Regulierstück 200 Serie 1	Dispositif de réglage de l'air 200 série 1	117 477 01
	Ljuddämpare 100 serie 1	Silencer 100 series 1	Schalldämpfer 100 Serie 1	Silencieux 100 série 1	117 113 01
	Luftspjäll kula 100 serie 1	Air damper ball 100 series 1	Luftklappe Kugel 100 Serie 1	Volet d'air bille 100 série 1	117 244 01 117 172 01
	Luftspjäll 100 serie 1	Air damper 100 series 1	Luftklappe 100 Serie 1	Volet d'air 100 série 1	115 929 01
	Luftspjäll 100 serie 2 150, 200	Air damper 100 series 2 150, 200	Luftklappe 100 Serie 2 150, 200	Volet d'air 100 série 2 150, 200	115 947 01
	Fjäder 100 serie 1	Spring 100 series 1	Feder 100 Serie 1	Ressort 100 série 1	117 805 01



Slangnippel
100, 150, 200

Hose nipple
100, 150, 200

Schlauchnippel
100, 150, 200

Raccord de
tuyau flexible
100, 150, 200

115 753 01



Spjällmotor
200

Servo motor
200

Stellmotor
200

Servo moteur
200

117 457 01



Fjäder
före 1996
150, 200-1 serie2
100 serie2

Spring
before 1996
150, 200-1 series2
100 series2

Feder
vor 1996
150, 200-1 Serie2
100 Serie2

Ressort
avant 1996
150, 200-1 série2
100 série2

117 931 01



Fjäder
150, 200 serie2

Spring
150, 200 series2

Feder
150, 200 Serie2

Ressort
150, 200 série2

118 156 01



Ställskruv
150, 200-1 serie2
100 serie2

Adjustment screw
150, 200-1 series2
100 series2

Stellschraube
150, 200-1 Serie2
100 Serie2

Vis de réglage
150, 200-1 série2
100 série2

117 494 01



Luftspjäll kpl.
200 serie1
200-2 serie2

Air damper compl.
200 series1
200-2 series2

Luftklappe kompl.
200 Serie1
200-2 Serie2

Volet d'air compl.
200 série1
200-2 série2

117 476 01



Luftreglering
kpl.
150, 200-1 serie2

Air regulation
compl
150, 200-1 series2

LuftEinstellung
kompl.
150, 200-1 Serie2

Réglage d'air
compl.
150, 200-1 série2

119 016 02

	Transformator 100, 200 serie 1, före W9703 100 serie 2	Transformer 100, 200 series 1, before W9703 100 series 2	Transformator 100, 200 Serie 1, vor W9703 100 Serie 2	Transformateur 100, 200 série 1, avant W9703 100 série 2	119 495 01
	Transformator kabel 150, 200 serie 2, efter W9703 100 serie 2	Transformer cable 150, 200 series 2, after W9703 100 series 2	Transformator Kabel 150, 200 Serie 2, nach W9703 100 Serie 2	Transformateur Câble H.T. 150, 200 série2, après W9703 100 série 2	115 977 03 117 570 02
	Joniseringskablar 100, 150, 200	Ionisation cables 100, 150, 200	Jonisationskabel 100,150 200	Câbles d'ionisation 100, 150, 200	119 014 01
	Tändkabel före W9703 100	Ignition cable before W9703 100	Zündkabel vor W9703 100	Câble H.T. avant W9703 100	117 923 04
	Tändkabelpar Biogas 150	Pair of ignition cable Biogas 150	Zündkabelpaar Biogas 150	Câble H.T. 1 paire Biogaz 150	117 064 04
	Tändkabel 310 mm 360 mm 440 mm 150, 200 serie 2, efter W9703 100 serie 2	Ignition cable 310 mm 360 mm 440 mm 150, 200 series 2, after W9703 100 series 2	Zündkabel 310 mm 360 mm 440 mm 150, 200 Serie 2, nach W9703 100 Serie 2	Câble H.T. 310 mm 360 mm 440 mm 150, 200 série 2, après W9703 100 série 2	118 135 01 118 135 02 118 135 03
	Tändkabel 200 serie 1	Ignition cable 200 series 1	Zündkabel 200 Serie 1	Câble H.T. 200 série 1	117 697 01
	Tändkabel värmebeständig m	Ignition cable heat resistant m	Zündkabel hitzebeständig m	Câble H.T. Résistant á la chaleur m	279 361 00
	Rajah koppling	Coupling, Rajah	Kupplung, Rajah	Accouplement, Rajah	076 702 01